

DWG NO. -

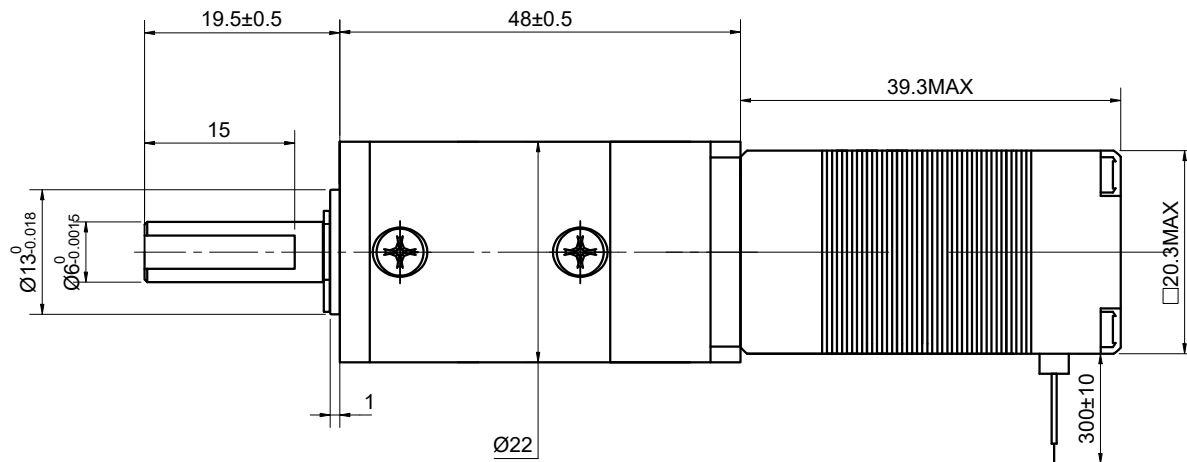
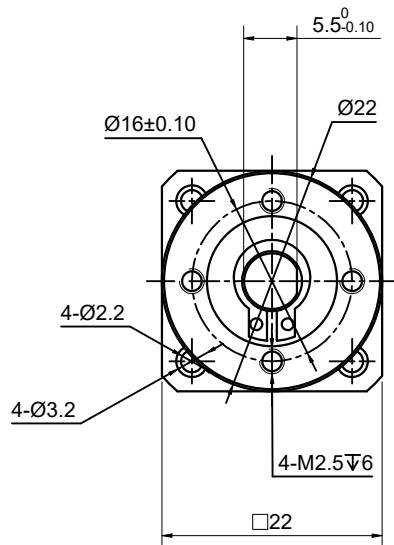

SPECIFICATION	VALUE
AMPS/PHASE	0.60
RESISTANCE/PHASE(Ohms)@25°C	11.00±10%
INDUCTANCE/PHASE(mH)@1KHz	5.50±20%
HOLDING TORQUE w/o GEARBOX(Nm)[lb-in]	0.04[0.35]
GEAR RATIO	20
EFFICIENCY	94%
STEP ANGLE w/o GEARBOX(°)	1.80
BACKLASH@NO-LOAD	<=20arcmin
MAX.PERMISSIBLE TORQUE(Nm)	4.00
MOMENT PERMISSIBLE TORQUE(Nm)	8.00
SHAFT MAXIMUM AXIAL LOAD(N)	100
SHAFT MAXIMUM RADIAL LOAD(N)	300
AMBIENT TEMPERATURE	-10°C~50°C[14°F~122°F]
INSULATION CLASS	B 130°C[266°F]
TEMPERATURE RISE	MAX.80°C

FULL STEP 2 PHASE-Ex.,WHEN FACING MOUNTING END (X)

STEP	A+	B+	A-	B-	CW	CCW
1	+	+	-	-	↓	↑
2	-	+	+	-	↓	↑
3	-	-	+	+	↓	↑
4	+	-	-	+	↓	↑

UNIT mm
GB/T 1804-M
EQV.ISO 2768-1
CLASS M:
<=6 ±0.1
>6~30 ±0.2
>30~120 ±0.3
>120~400 ±0.5

MOTOR CONNECTION			
PIN NO	BIPOLAR	LEADS	
1	A+	BLK	
2	A-	GRN	
3	B+	RED	
4	B-	BLU	

OSMTEC[®]
Stepper Motor Specialists

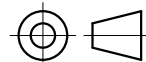

mm			
UNITS	DRN	ZPJ	1.12.2026
3:2	APVD	YSX	1.12.2026
SCALE	SIGNATURE	DATE	

GEARBOX MOTOR
8HS15-0604S-EGS20