

DWG NO. -

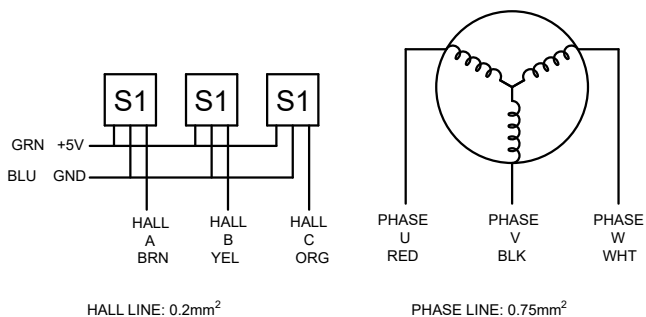
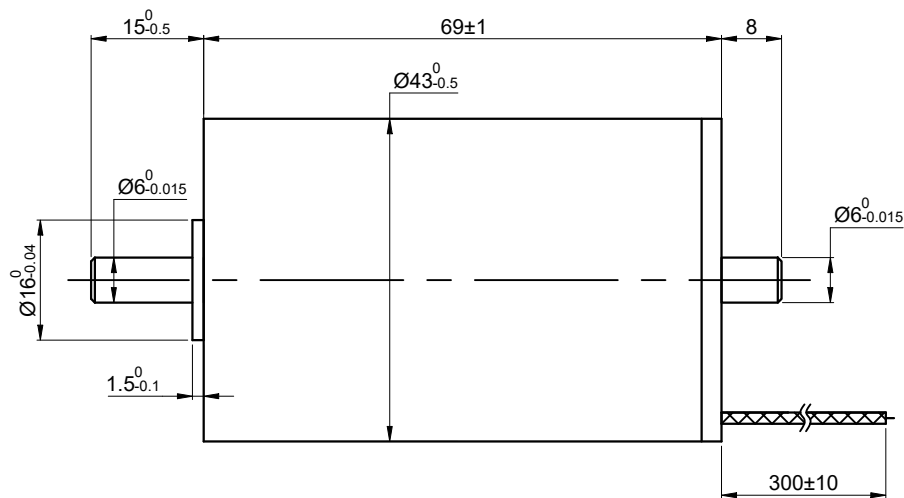
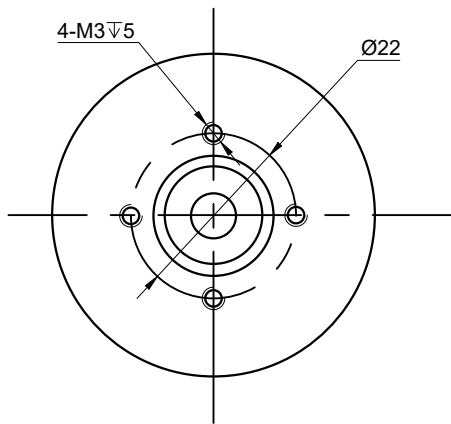

SPECIFICATION	VALUE
RATED VOLTAGE(V)	24
TERMINAL RESISTANCE(Ohms)	0.32
TERMINAL INDUCTANCE(mH)	0.08
NO LOAD SPEED(RPM)	7000
NO LOAD CURRENT(A)	0.45
RATED SPEED(RPM)	5000
RATED CURRENT(A)	6.15
RATED TORQUE(mNm)	200
RATED POWER(W)	104.71
THE GREATEST POWER OUTPUT(W)	444.62
EFFICIENCY(%)	85.11
TORQUE CONSTANT (mNm/A)	32.54
STALL TORQUE (mNm)	2426.16
BACK-EMF CONSTANT (mV/RPM)	3.41
SPEED CONSTANT (RPM/V)	293.43
FRICITION TORQUE(mNm)	14.64
CURRENT CONSTANT (A/mNm)	0.03

UNIT mm
GB/T 1804-M EQV.ISO 2768-1 CLASS M:

<=6	±0.1
>6~30	±0.2
>30~120	±0.3
>120~400	±0.5

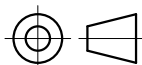

mm			
UNITS	DRN	MYX	1.13.2026
3:2	APVD	LDJ	1.13.2026
SCALE	SIGNATURE	DATE	

BRUSHLESS DC MOTOR

43CL70-24-P2-5000

OSMTEC®
Stepper Motor Specialists