

DWG NO. -

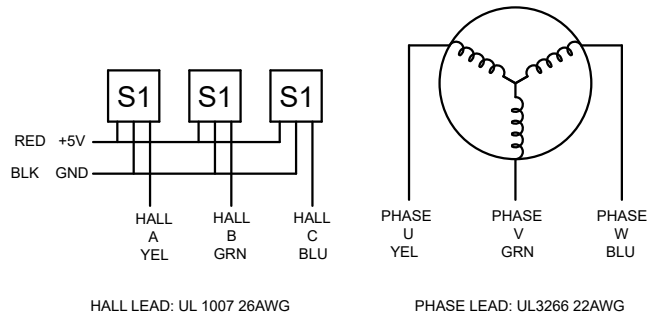
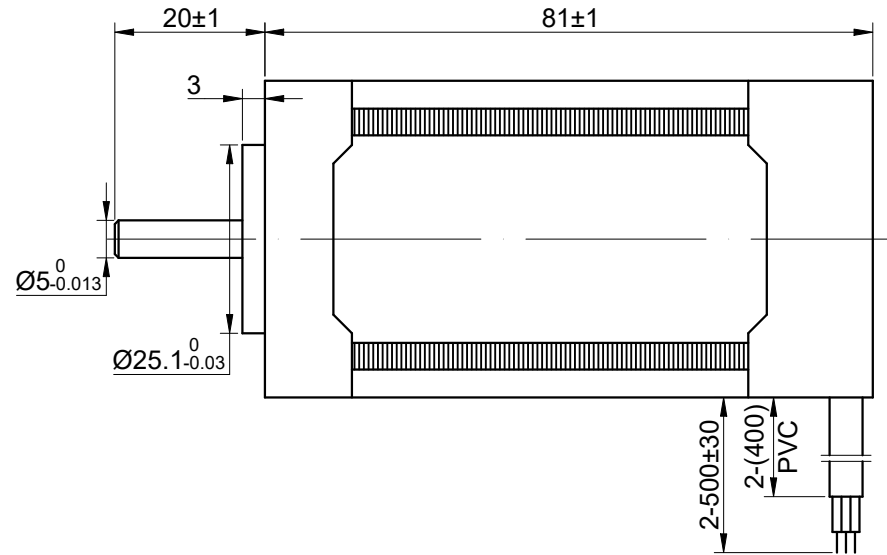
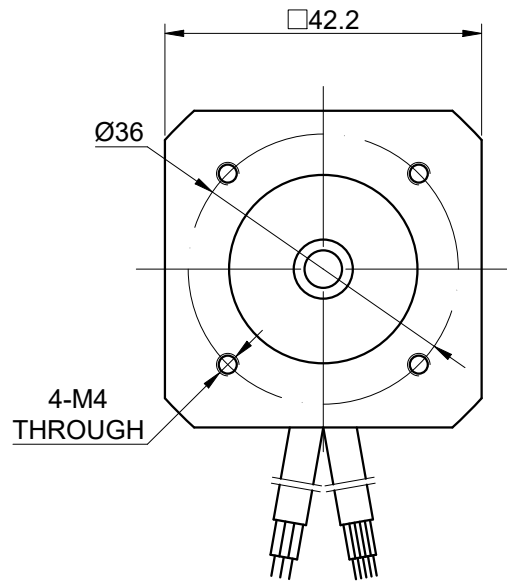

SPECIFICATION	VALUE
NO. of PHASES	3
NO. of POLES	8
RESISTANCE/PHASE(Ohms)@25°C	4.03±10%
INDUCTANCE/PHASE(mH)@1KHz	4.50±20%
RATED VOLTAGE(V)	48
RATED TORQUE(N.m)[lb-in]	0.19[1.68]
RATED POWER(W)	60
RATED SPEED(RPM)	3000±10%
RATED CURRENT(A)	1.80
NO LOAD SPEED(RPM)	4100±10%
WEIGHT(kg)	—
BACK EMF(V/krpm)	8.20±5%
SENSOR	HALL
AMBIENT TEMPERATURE	-10°C~50°C[14°F~122°F]
INSULATION CLASS	B 130°C[266°F]
TEMPERATURE RISE	MAX.80°C

UNIT mm
GB/T 1804-M EQV.ISO 2768-1 CLASS M:

<=6	±0.1
>6~30	±0.2
>30~120	±0.3
>120~400	±0.5

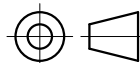

mm

UNITS	DRN	MYX	1.15.2026
3:2	APVD	LDJ	1.15.2026
SCALE	SIGNATURE	DATE	

BRUSHLESS DC MOTOR

42BSB81-48-01

OSMTEC®
Stepper Motor Specialists