

DWG NO. -

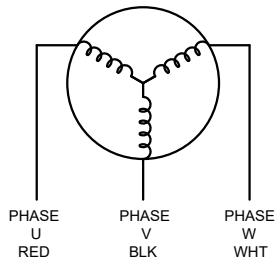
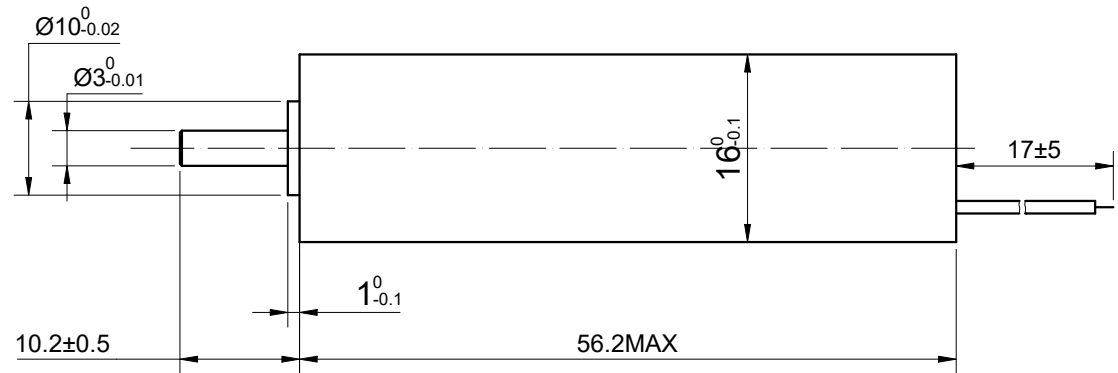
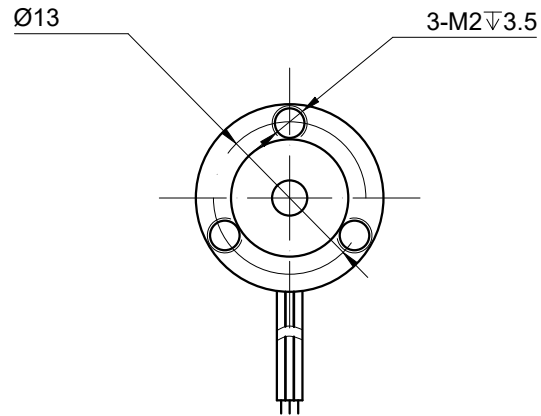

PHASE LINE: 0.2mm²

SPECIFICATION	VALUE
RATED VOLTAGE(V)	32
TERMINAL RESISTANCE(Ohms)	2.2
TERMINAL INDUCTANCE(mH)	0.12
NO LOAD SPEED(RPM)	40000
NO LOAD CURRENT(A)	0.12
RATED SPEED(RPM)	32000
RATED CURRENT(A)	1.35
RATED TORQUE(mNm)	10.2
RATED POWER(W)	34.18
THE GREATEST POWER OUTPUT(W)	114.45
EFFICIENCY(%)	82.66
TORQUE CONSTANT (mNm/A)	7.58
STALL TORQUE (mNm)	109.29
BACK-EMF CONSTANT (mV/RPM)	0.79
SPEED CONSTANT (RPM/V)	1260.40
FRICITION TORQUE(mNm)	0.91
CURRENT CONSTANT (A/mNm)	0.13

UNIT mm
GB/T 1804-M EQV.ISO 2768-1 CLASS M:

<=6	±0.1
>6~30	±0.2
>30~120	±0.3
>120~400	±0.5

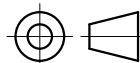

mm			
UNITS	DRN	MYX	1.13.2026
3:2	APVD	LDJ	1.13.2026
SCALE	SIGNATURE	DATE	

OSMTEC®
Stepper Motor Specialists

BRUSHLESS DC MOTOR

16CL56-32-P2-32000